

LohrElement® Deckenrandschalung

Typ S35, DF50

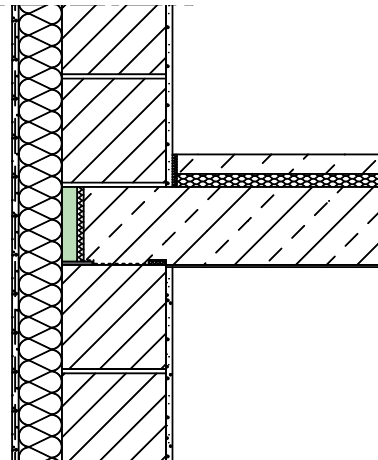

WDVS Wandkonstruktion

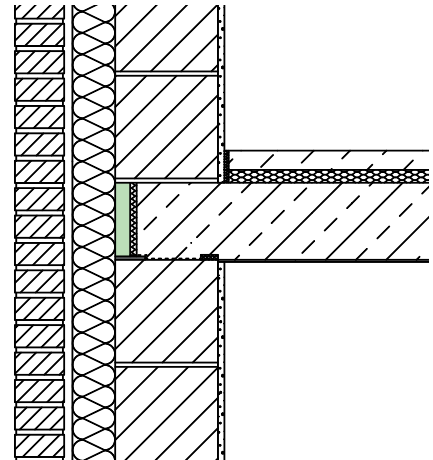

Mehrschalige Wandkonstruktion

Typ DF60, DF80 und DF100

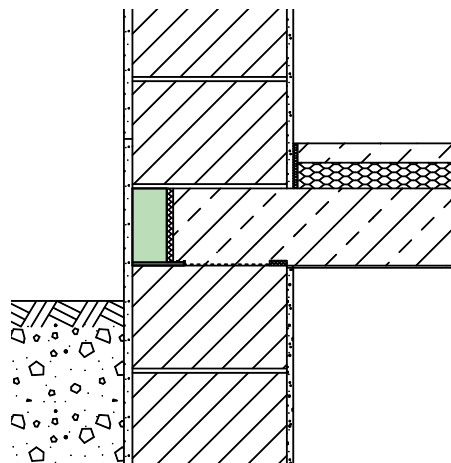

Monolithische Wandkonstruktion

Typ DW60

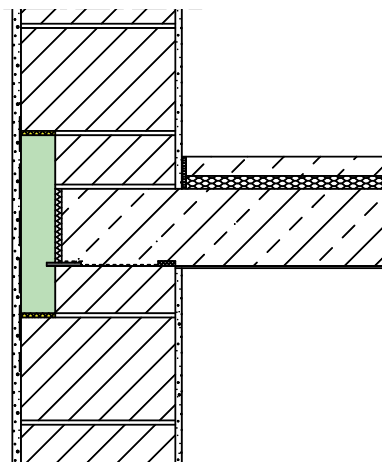

Monolithische Wandkonstruktion

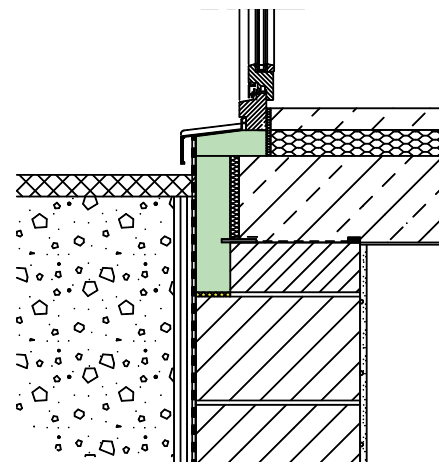

Monolithische Wandkonstruktion

LohrElement® Deckenrandschalung

Typ DW60

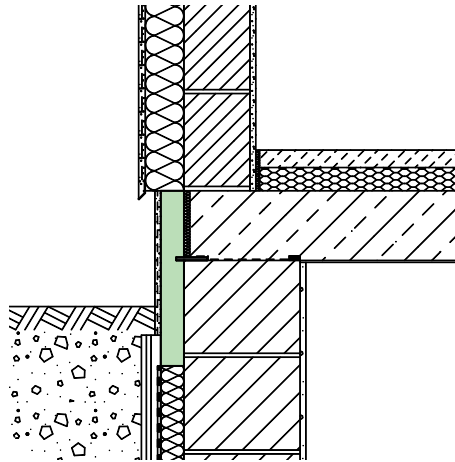

WDVS Wandkonstruktion

Typ F, FA und FS

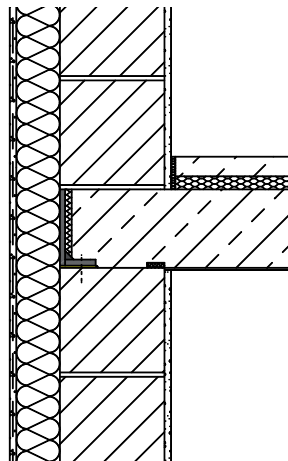

WDVS Wandkonstruktion

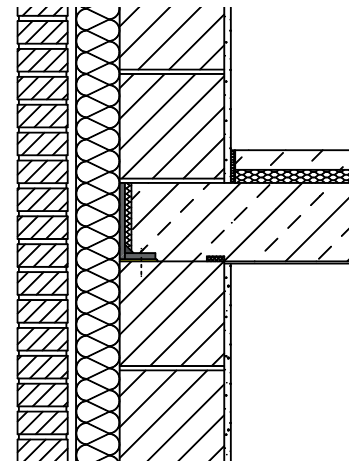

Mehrschalige Wandkonstruktion

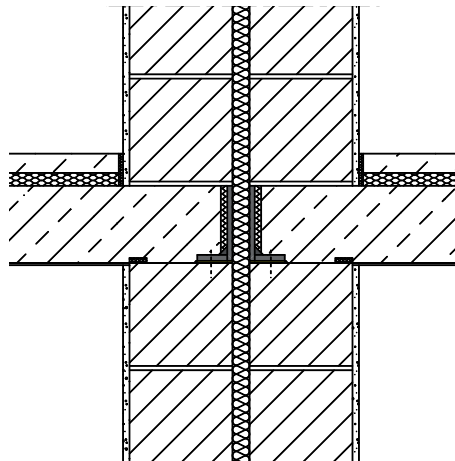

Haustrennwände

LohrElement® Abschaltbrett

Typ B

